

DECORA FLOAT BOARD

デコラ フロートボード

Year of Production 2023-



Designer : MASTERWAL



DRFB22640-B-WN

壁付仕様		WN RO BC		
W2260	A	D402 H280	DRFB22640-A-WN/RO/BC	¥236,500
	B	D402 H280	DRFB22640-B-WN/RO/BC	¥258,500
W1810	A	D402 H280	DRFB18140-A-WN/RO/BC	¥209,000
	B	D402 H280	DRFB18140-B-WN/RO/BC	¥231,000
W1507	A	D402 H280	DRFB15040-A-WN/RO/BC	¥176,000
	B	D402 H280	DRFB15040-B-WN/RO/BC	¥198,000
	C	D402 H280	DRFB15040-C-WN/RO/BC	¥198,000
W1207	A	D402 H280	DRFB12040-A-WN/RO/BC	¥154,000
	B	D402 H280	DRFB12040-B-WN/RO/BC	¥176,000
	C	D402 H280	DRFB12040-C-WN/RO/BC	¥176,000

本体：突板 / ウレタン塗装
 前板：突板 / ウレタン塗装
 フラップ扉：無垢材 / ウレタン塗装
 ブラックガラス（強化）
 天板面：配線孔スクエア
 ※設置工事費別途



配線孔スクエア

A タイプ
 引出し
 B、C タイプ
 引出し + フラップ扉

ウレタン塗装 **OPB / RO + ¥33,000**

配線加工 **1箇所**
 天板 配線孔スクエア 追加 **+ ¥6,600**
 配線孔 (Φ30 or Φ50 相当) **+ ¥6,600**
 配線孔 キャップ付き (Φ30 or Φ50 相当) **+ ¥8,800**
 コンセント (2口) **+ ¥15,400**

オプション

B,C タイプ - フラップ扉 突板ガラス仕様

WN RO BC + ¥22,000

フラップ扉（突板ガラス仕様）
 突板 / ウレタン塗装
 クリアガラス（強化）



標準仕様



突板ガラス仕様

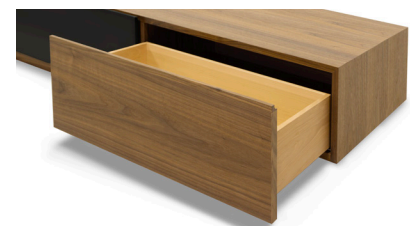

引出し



フラップ扉

DECORA FLOAT BOARD

デコラ フロートボード

Year of Production 2023-



Designer : MASTERWAL

W2260 A

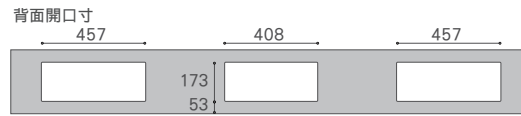
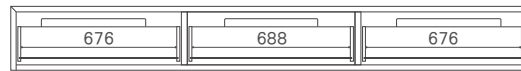
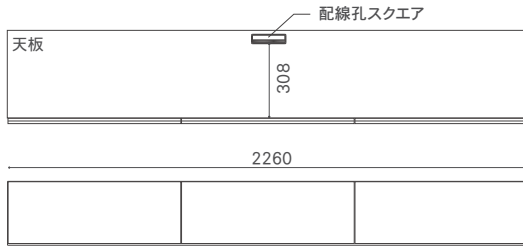

引出部内寸

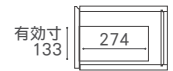

W2260 B

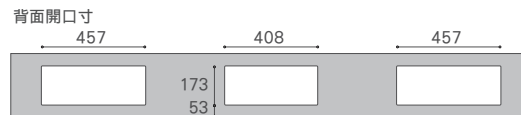
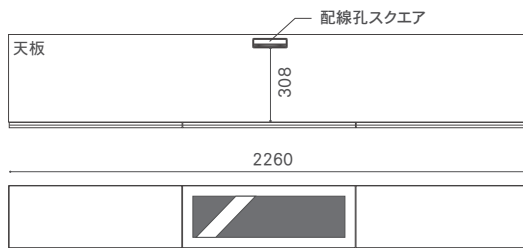

引出部内寸

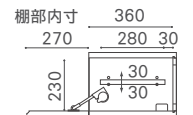
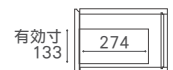

W1810 A

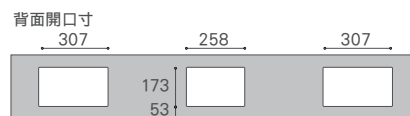
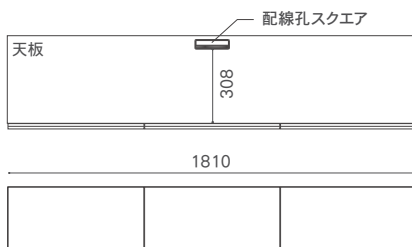

引出部内寸

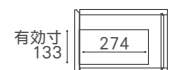

W1810 B

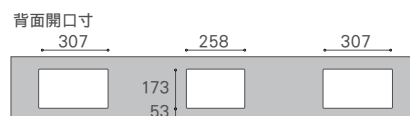
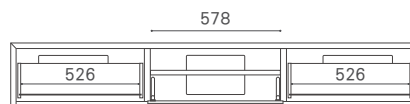
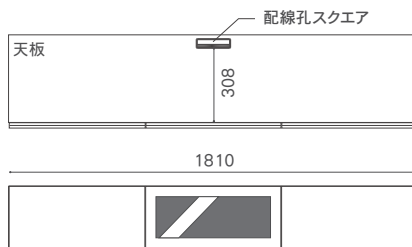

引出部内寸

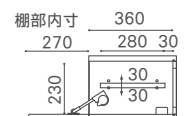
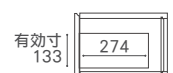

DECORA FLOAT BOARD

デコラ フロートボード

Year of Production 2023-



Designer : MASTERWAL

W1507 A

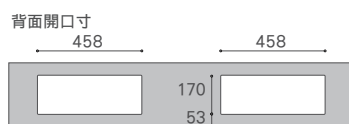
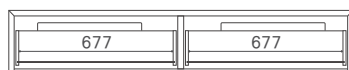
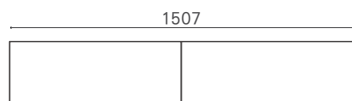
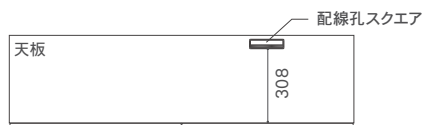

引出部内寸



W1507 B

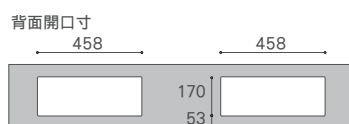
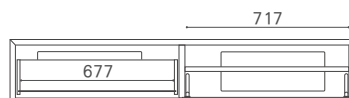
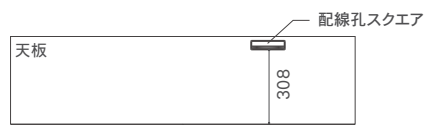

引出部内寸

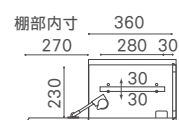
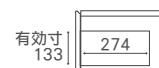

W1507 C

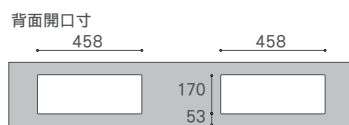
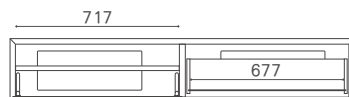
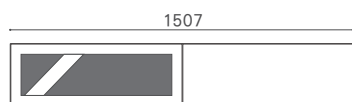
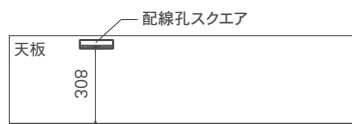

引出部内寸

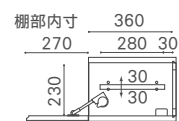

DECORA FLOAT BOARD

デコラ フロートボード

Year of Production 2023-



Designer : MASTERWAL

W1207 A

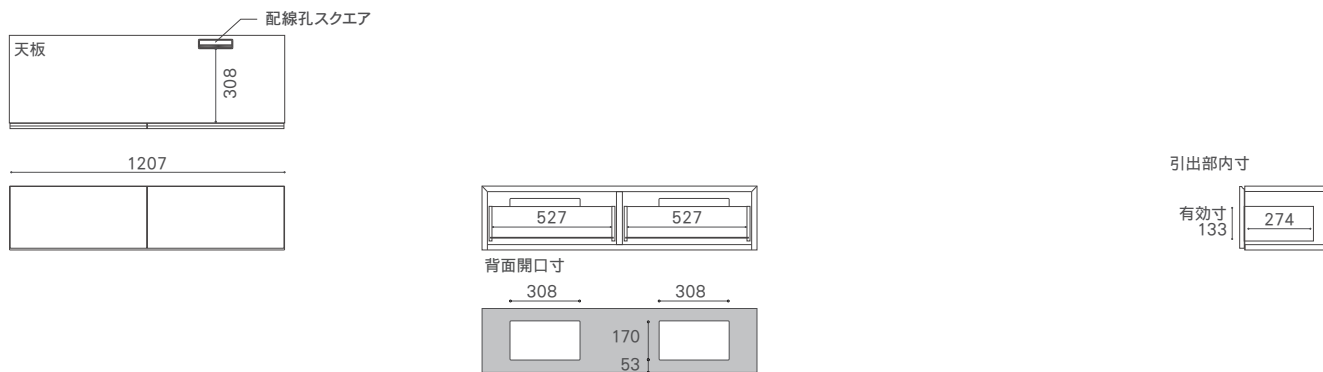

W1207 B

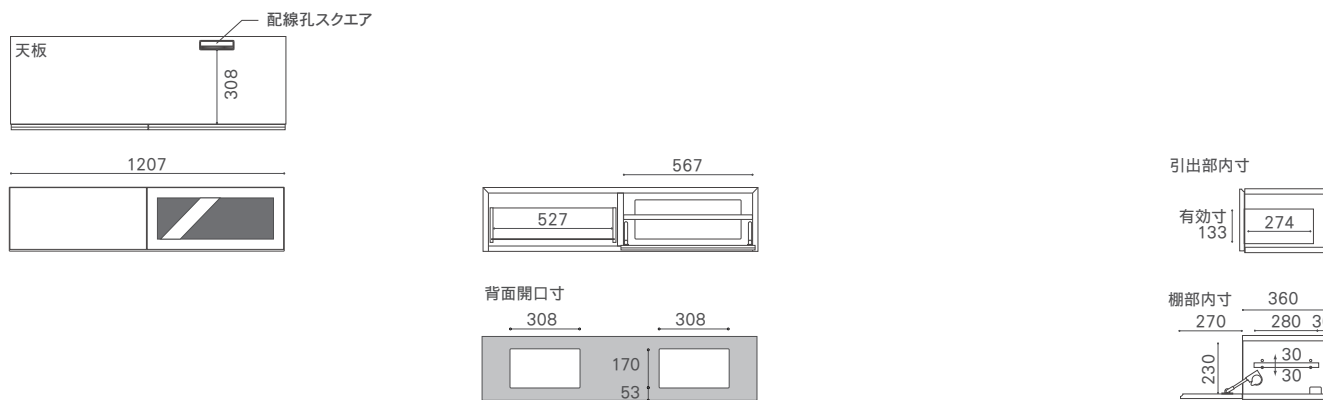

W1207 C

